

ALVOLTA DISTRIBUTION HUB

ADHUB150

Key Features:

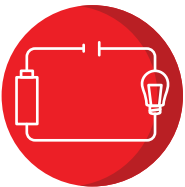

10 Individual Circuits



4 AMI/Midi Connections

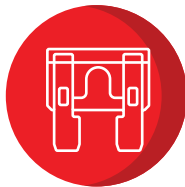

6 ATO/ATC Connections



Protective Cover



Negative Busbar

Suitable for:



5 YEAR
WARRANTY

ALVOLTA DISTRIBUTION HUB

ADHUB150

Specifications:

Maximum Input Voltage	32V DC
Maximum Input Current	100A
Circuits	10
AMI/Midi Connection	4x Connection Points
ATO/ATC Connection	6x Connection Points
Suitable Ring Terminal	M8 (5/16") Recommended
Thread Terminal	M8 Studs
Terminal Material	Stainless Steel
Contact Strip Material	Nickle-Plated Copper
Base Material	PBT Plastic
Cover	Translucent Plastic (PC)
Colour	Black
Dimensions	198 x 140 x 52mm

Model Diagram:

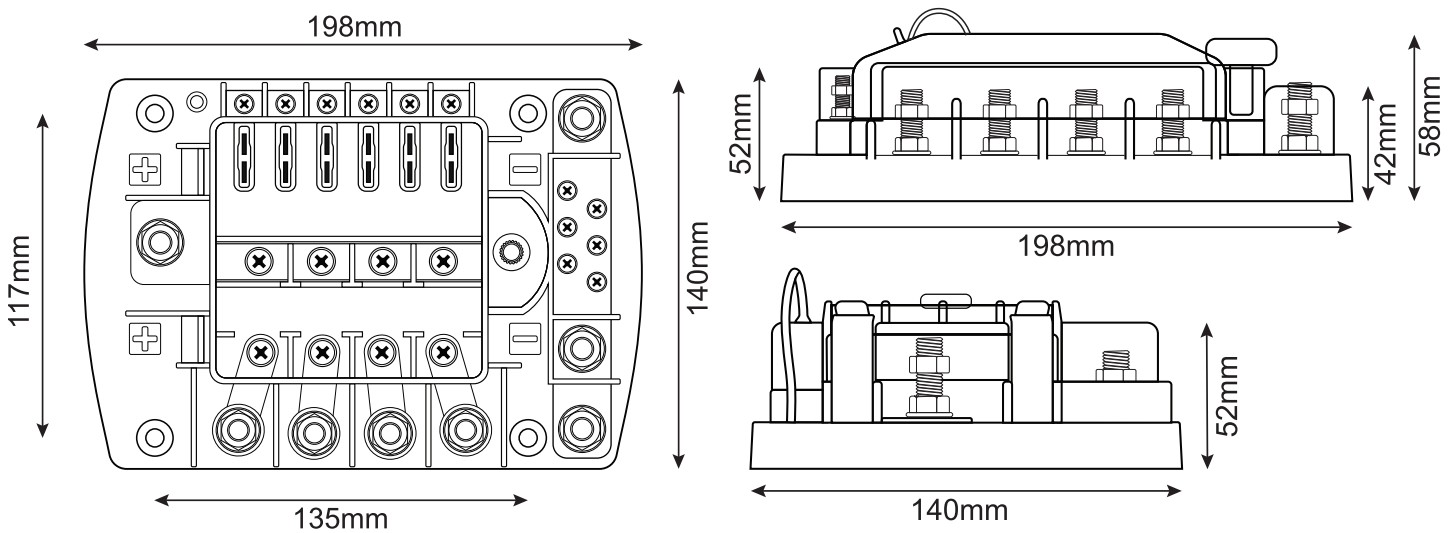

Inclusions:

- Fuse Block
- Fuse Puller
- 4x AMI/Midi Fuses
- 16x ATO/ATC Fuses
- Labelling Stickers

ALVOLTA DISTRIBUTION HUB ADHUB150

Wiring Diagram:

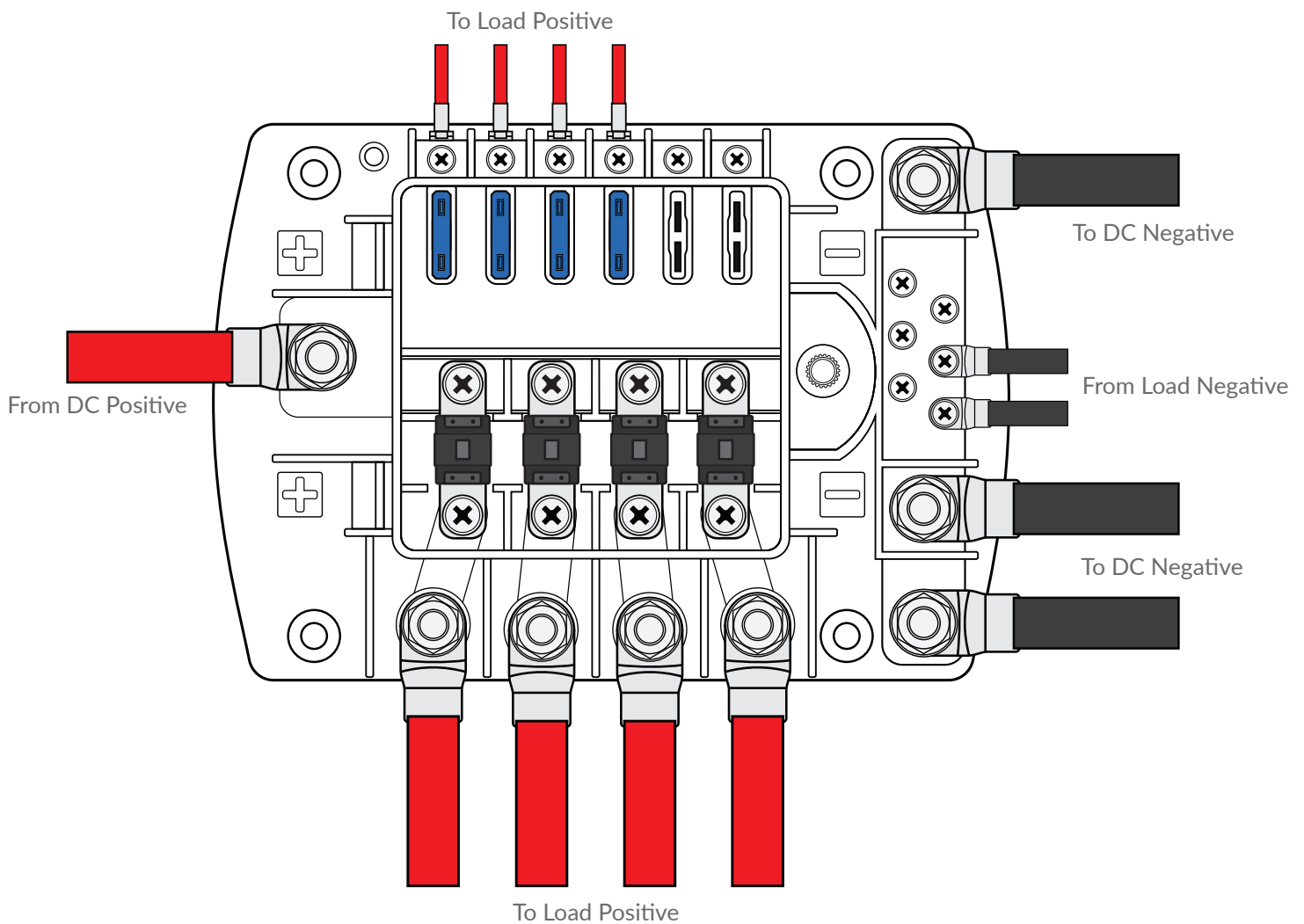

*All data and specifications provided in this datasheet are tested under standard test conditions, and may deviate marginally from actual values. Alvolta and its associates reserve the right to make modifications to the provided information without notice. Alvolta maintains the goal to supply customers with the most recent information regarding its products.