

## ALVOLTA M6 4 POINT 150A BUSBAR

ABB1504BC & ABB1504RC

### Key Features:



4 Connection Points



Protective Cover



Durable Nylon Base



Copper Contact



Mounting Screws Included

### Suitable for:



**3 YEAR**  
WARRANTY

# ALVOLTA M6 4 POINT 150A BUSBAR

## ABB1504BC & ABB1504RC

### Specifications:

Model	ABB1504BC	ABB1504RC
Colour	Black	Red
Maximum Current Rating	150A	
Maximum Voltage Rating	48V	
Connection Post Size	6mm (M6)	
Connection Post Material	Stainless Steel	
Cover Material	Translucent Plastic	
Base Material	Glass Fiber Reinforced Nylon	
Fixings Material	Stainless Steel	
Contact Strip Material	Copper Alloy	
Dimensions	126 x 20 x 49mm	

### Model Diagram:

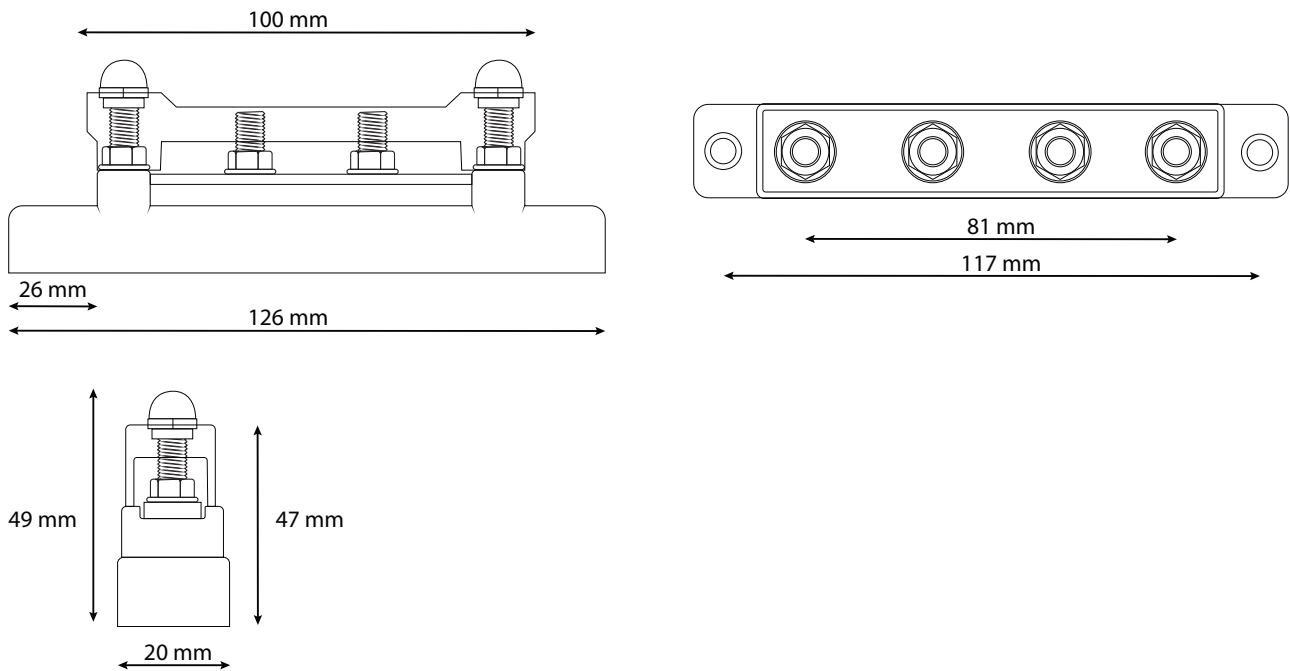

### Inclusions:

- Fuse Block
- Fuse Block Cover
- 2x Mounting Screws

\*All data and specifications provided in this datasheet are tested under standard test conditions, and may deviate marginally from actual values. Alvolta and its associates reserve the right to make modifications to the provided information without notice. Alvolta maintains the goal to supply customers with the most recent information regarding its products.